

heavy duty hinge 40x40
for 40 series profiles

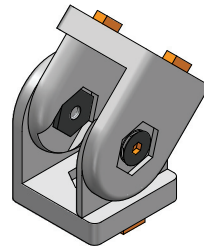
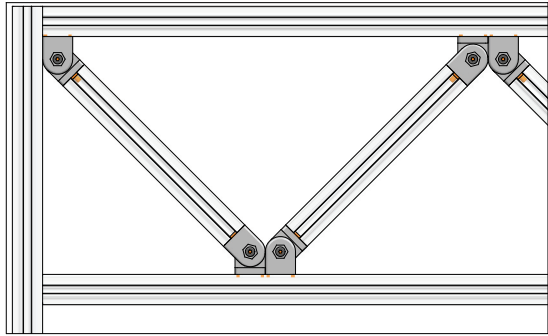

heavy duty hinge 40x40
Part Number 373.31

for connecting profiles
at various angles, suits
40 series profiles
supplied with eight
locating blocks

Material: Zn/cast

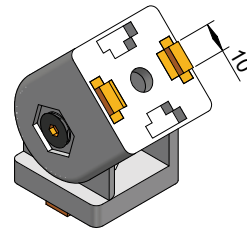

heavy duty hinge 30x30
Part Number 373.33

suits 30 series profiles

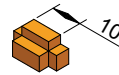

locating block
inserted into hinge base
according to aluminium
profile slot direction

four blocks for end
profile connection

two blocks for profile
slot connection

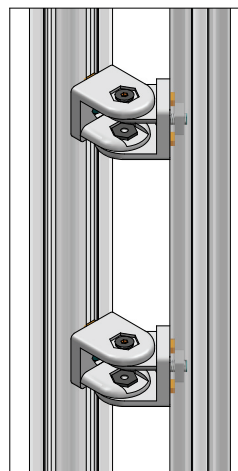
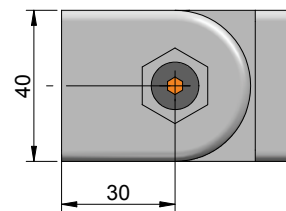
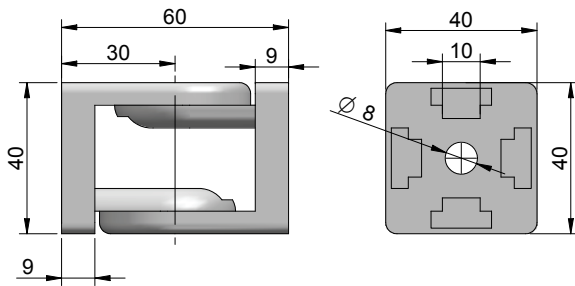

1.

possible uses:
1. heavy doors
2. swivel type arm

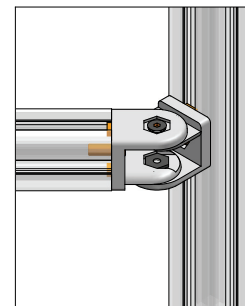

2.