

sliding door block

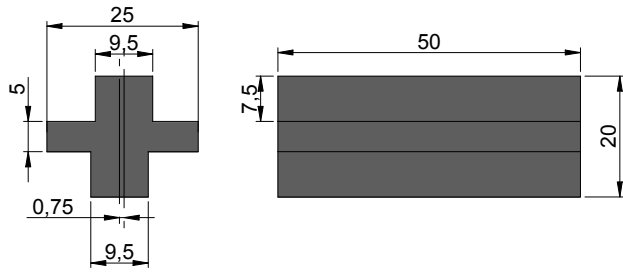

typical application

for construction of sliding doors used for horizontal or vertical installations with framed panel elements.

to be installed as per shown diagram and drawings below

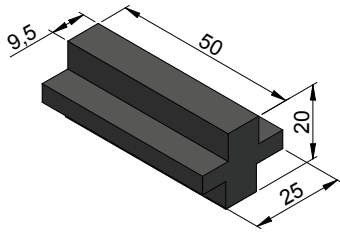

sliding block set
Part Number: 406.66

4 sliding block pieces
8 self-tapping screws

used with 40 & 30 series profiles

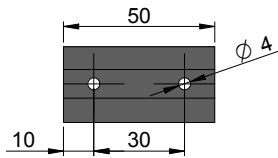

1. drill two 4mm holes in sliding block as shown

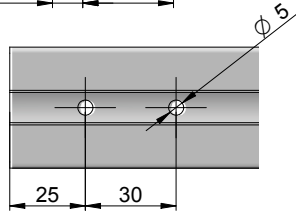

2. drill two 5mm holes on each end of aluminium profile as shown

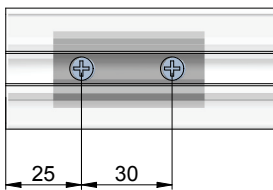
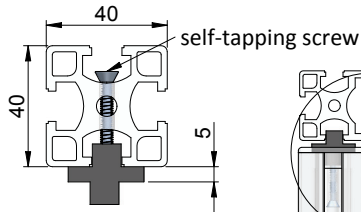
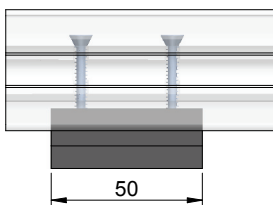

3. tighten sliding block to aluminium profile using self-tapping screws

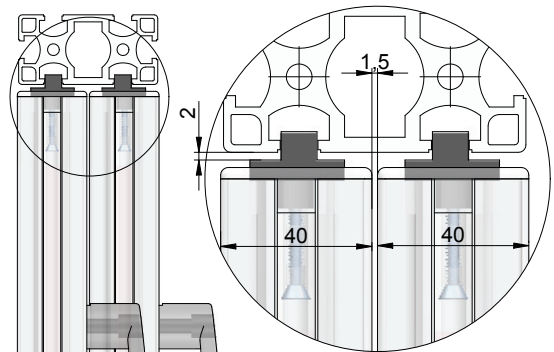
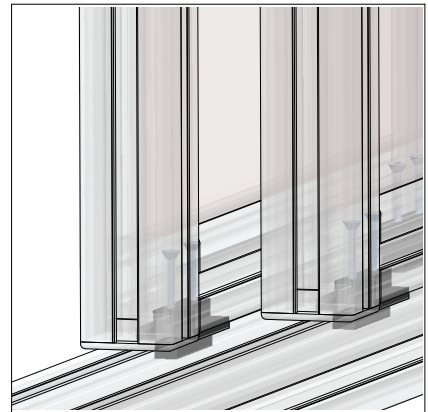
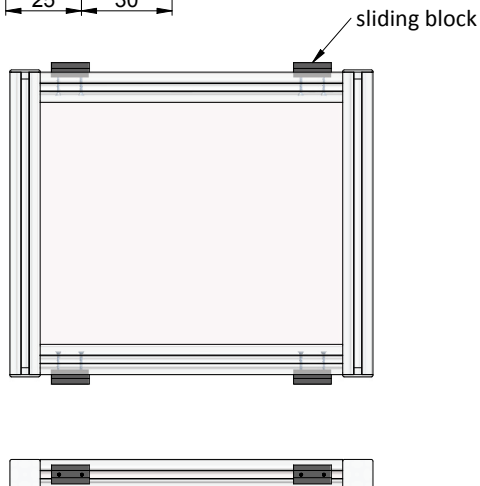

installation hint: for sliding block with offset guides

Ensure sliding door block are assembled facing inward direction both top and bottom rail.

Both sliding doors should be installed into frame with guides facing inwards to each other for 1.5mm clearance between door frames.

Allow minimum 2mm clearance for vertical height