

ErgoStyle/ErgoMan workstations  
accessories overview

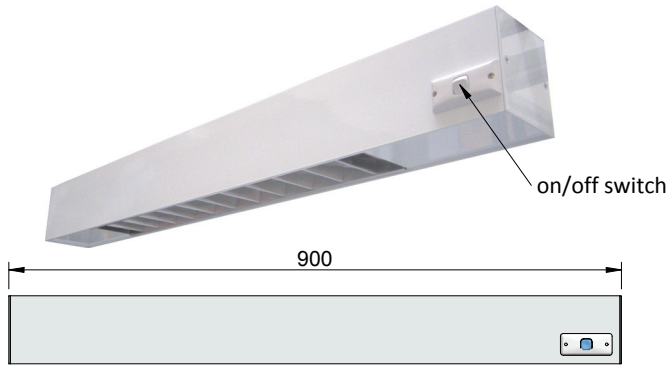

**overhead light unit**  
**Part Number: 386.10**

material: aluminium powder coated  
with built-in on/off switch

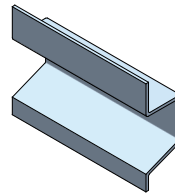
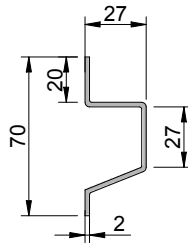
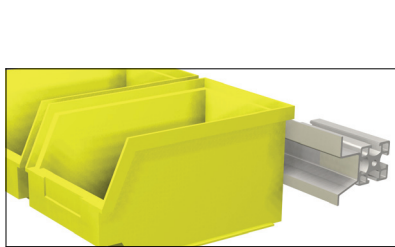
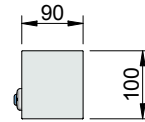

**bin holder rail profile**  
**Part Number: 026.70**

material: aluminium, mill finish  
maximum length: 4000mm

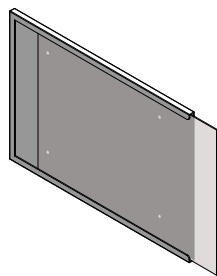
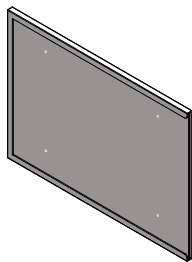

clear cover

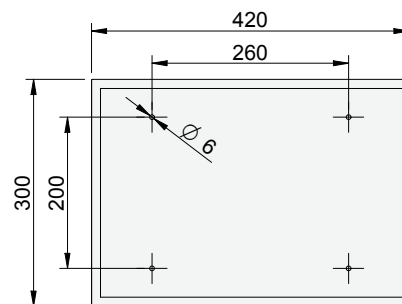

vertical mount

horizontal mount



**A3 size card holder**  
**Part Number: 406.30**

material: 1.2mm steel, powder coated  
colour - silver grey

card holder with four countersink  
mounting holes to suit M6 screw and  
2mm clear cover

can be mounted vertically or  
horizontally in two height positions